

Description:

The Warthog® WT-3/8 is a rotary sewer nozzle designed to clean 3 to 6 inch pipes and sewers with elbows. The tool can be used at operating pressures up to 4000 psi (275 bar). There are two heads available; one for flow rates of 3 to 7 gpm and one for 8 to 12 gpm. Jet thrust powers rotation and also pulls the tool through the line. The front jet is useful for unblocking pipes. It is possible to use the front jet fights against the pulling power of the rear jets by plugging the front jet to allow the tool to pull itself down the line. A thick viscous fluid inside the tool controls the rotation speed.

The WT has a 3/8 NPT pipe thread inlet. We recommend that 3/8 ID hose be used; if 1/4 inch hose is used, too much pressure is lost. (At 5 gpm, each 100 ft of 1/4" hose will take away 700 psi due to friction.) Pumps are commonly sold based on their theoretical maximum flow output; in reality, none are 100% efficient. We try to take this into account when supplying you the jets. If you are not getting to the operating pressure desired, the sizes of the jets may need to be changed. Contact your distributor or go to www.sewernozzles.com for help.

Operation:

Before connecting the tool to the end of the hose, flush the jetter hose to remove debris. Attach the tool to the end of the hose; we recommend using teflon tape to seal the threads. Note that there is a large O-Ring (WT 030) around the inlet, covering up the wrench flats. This O-Ring helps prevent the tool from getting caught on the rear edge when pulling the tool back out of the line. When attaching the tool to the hose end, slide the O-Ring up the hose out of the way until the connection is tightened, and then roll the O-Ring back into its original place. Position the tool within the pipe to be cleaned; bring the pump up to pressure, making certain that the Warthog begins to pull its way in the proper direction into the pipe. Once the pump is up to pressure, feed the Warthog at a reasonable rate to allow the jets time to clean the pipe. If roots are present, feeding at a slower rate will improve the cleaning results. Depending on the amount of debris in the pipe, it may be necessary to occasionally pull the Warthog back toward the pipe entrance to prevent large buildups behind the tool.

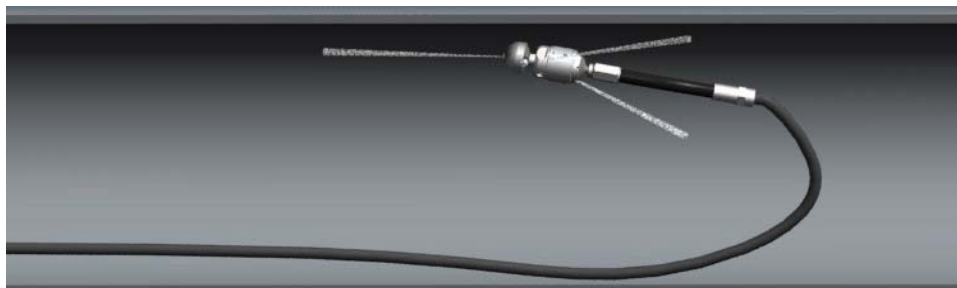

Do not use the WT in pipes larger than 6 inches, as the tool can turn around and come back toward the operator, causing serious injury or death.

When finished cleaning, shut down and secure pump before removing Warthog from line. If the Warthog will be removed from the line and stored for more than several days, blow out water with compressed air to prolong the life of the internal components. **The most important item in maintaining the WT is keeping the tool full of viscous fluid. We recommend that this is done after every 40 to 50 hours of operation. If the tool is spinning much faster than when new, this is an indication that it needs fluid.**

Troubleshooting:

Head will not rotate: First try rotating head by hand and see if it feels rough or gritty to turn. If it does, the tool must be disassembled and repaired; it likely has bad bearings, seals and fluid. If the tool feels okay, check to see if any nozzles are plugged; even if a nozzle is only partially blocked it can keep the head from rotating. Nozzles must be removed from the head to properly clean them; it does not do any good to poke the material plugging the nozzle back into the head, as it will just replug a nozzle.

Head spins too fast: It is likely that the swivel is low on viscous fluid, or the viscous fluid has water in it. The best thing to do is drain all the fluid, wipe the parts clean and refill with the proper fluid. Check that the shaft seals are still good and will keep the fluid from leaking out.

Seal Leak: The seal may leak initially at low pressure, but should pop closed as pressure is increased. If operating pressure is reached and the seal is leaking continuously, the high pressure seal may need to be replaced. Refer to the maintenance below.

Seals wear out quickly: The tool must be disassembled and inspected. The brass seat should be checked for being installed in the right direction, and it should be replaced any time the high pressure seal is replaced. The bore of the shaft where the high pressure seal is located should be checked for grooving. If it is worn larger than .322", the shaft will need to be replaced.

Maintenance:

The most important item in maintaining the WT is keeping the tool full of viscous fluid. We recommend that this is done after every 40 to 50 hours of operation. If the tool is spinning much faster than when new, this is an indication that it needs fluid. *Blow out all water with compressed air before storing tool!

The Warthog also has a high pressure seal that will last between 150 and 300 hours. The seal may leak at low pressure, but will seal at high pressures unless it has worn out. Refer to the other side of this sheet for seal replacement.

To fill the tool with viscous fluid:

1. Fill the syringe with viscous fluid. This is best done by unscrewing the handle from the tube and pulling out the plunger. Pour fluid into the tube; reassemble the syringe.
2. Hold the Warthog with the hose end up as shown. Remove the Port Screw (BJ 026) from the Warthog. Thread the syringe fitting into the port, and slowly squeeze fluid into swivel until excess fluid comes out around the inlet end. If the fluid coming out appears dirty or watery, keep squeezing in new fluid until it comes out clean.
3. Remove syringe from Warthog, install Port Screw.

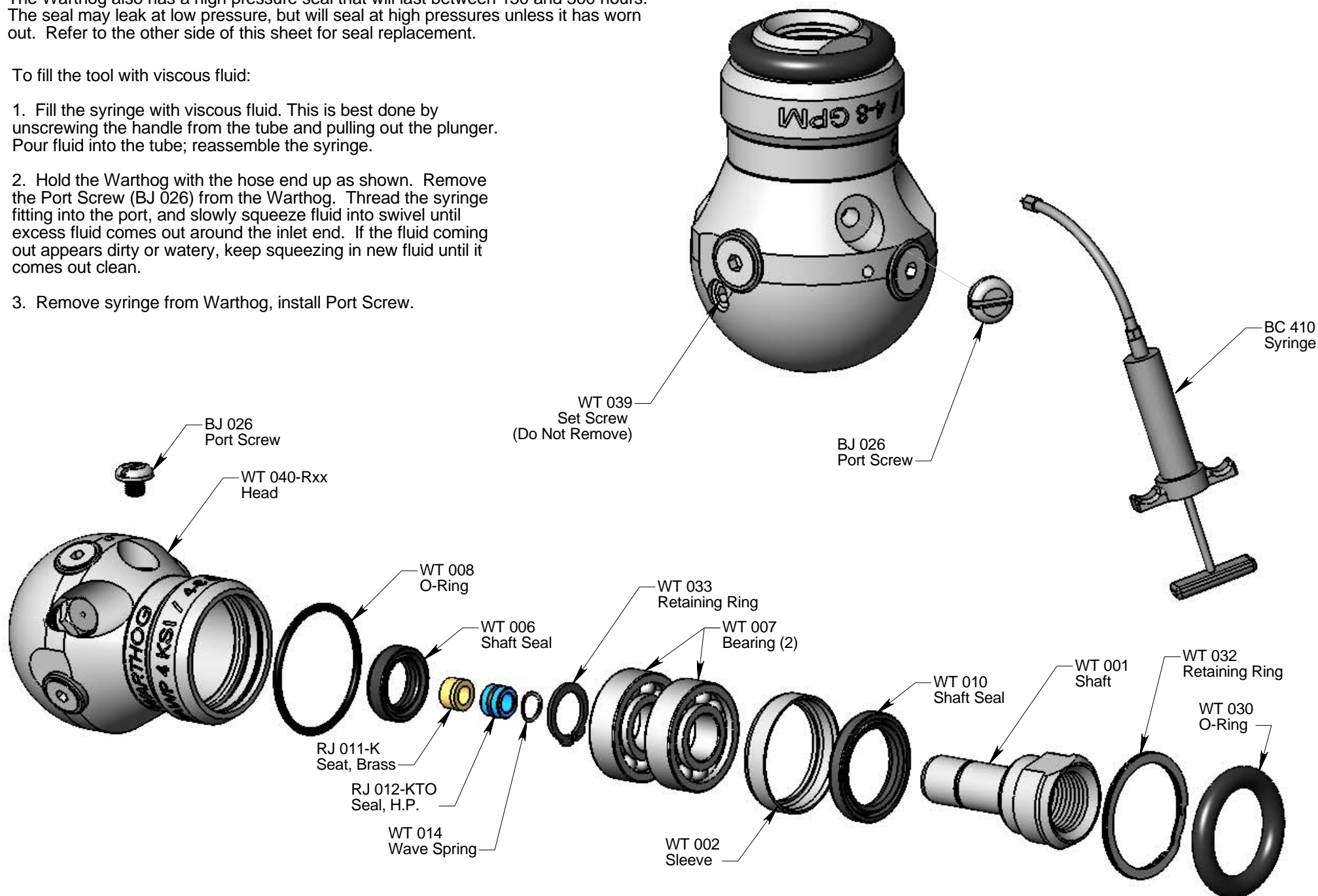

Disassembly:

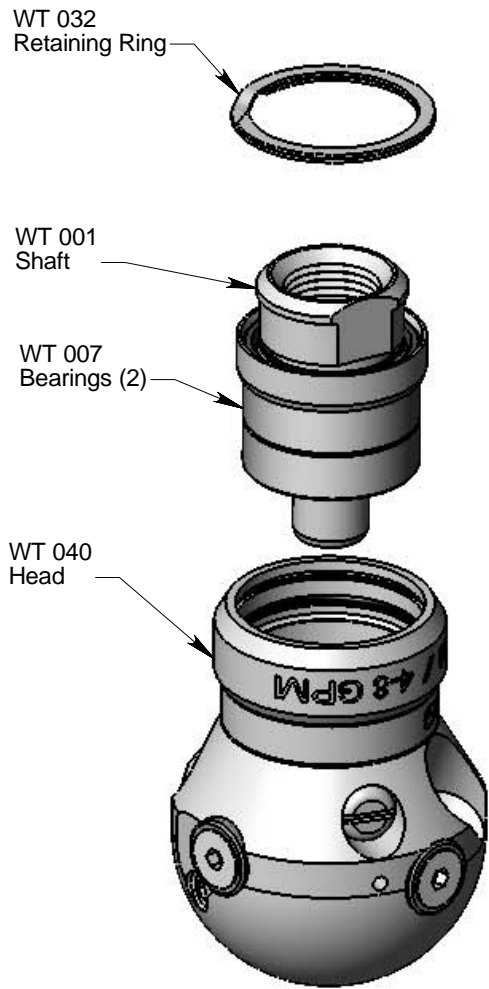

1. Remove the Retaining Ring (WT 032) at the rear end of the Warthog.
2. Pull the Shaft (WT 001) out of the Head (WT 040). The bearings and other parts will come out with the Shaft.
3. Remove the Seat (RJ 011-K), H.P. Seal (RJ 012-KTO) and Wave Spring (WT 014) from the Shaft.
4. Remove the Retaining Ring (WT 033) from the Shaft. Pull the Shaft out of the Bearings.

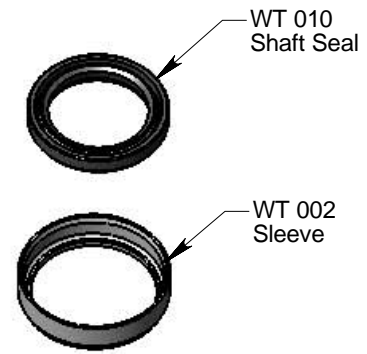
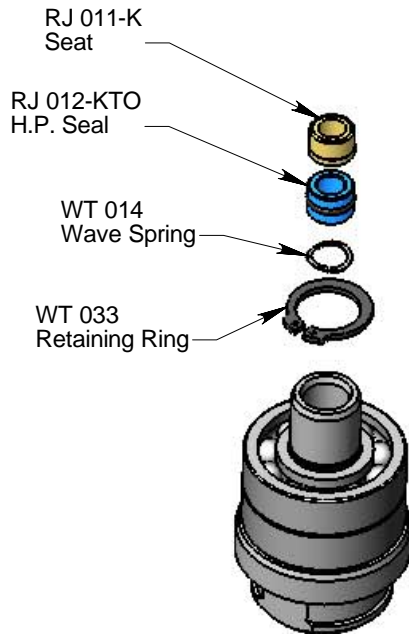

5. Remove the Shaft Seal (WT 010) from the Sleeve (WT 002).
6. Remove the Shaft Seal (WT 006) from the Head (WT 040); be careful not to scratch the face below this seal.
7. Remove the O-Ring (WT 008) from the Head.

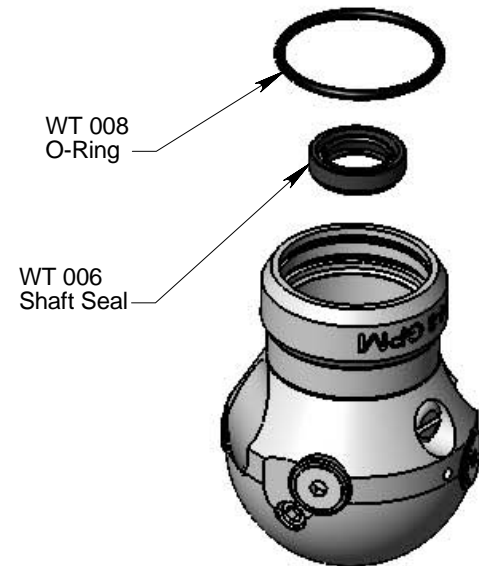

Assembly:

1. Install Shaft Seal (WT 006) in Head. Note the direction of the seal.
2. Install O-Ring (WT 008) in Head. Note that the O-ring goes in the second groove.
3. Install Shaft Seal (WT 010) in Sleeve (WT 002). Note direction of seal. Apply grease to the lips of the seals.

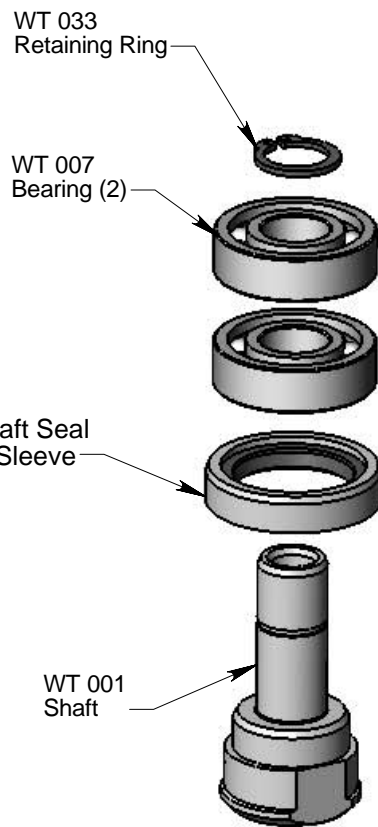
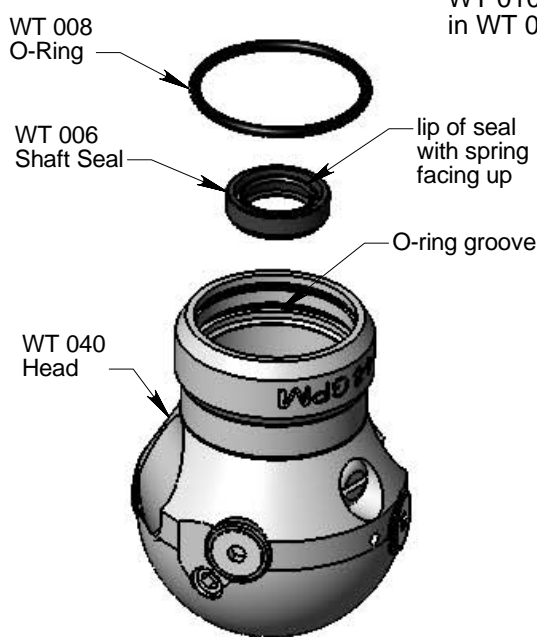

4. Slide Shaft (WT 001) thru Shaft Seal in Sleeve, thru both bearings (WT 007), and install the Retaining Ring (WT 033) on shaft above bearings. Make sure it seats well in the groove in the shaft.
5. Install Wave Spring (WT 014) in bore of Shaft. Apply grease to H.P. Seal (RJ 012-KTO). Slide into bore of Shaft.
6. Apply grease to the flat face (the end with the larger diameter) of the Seat (RJ 011-K) and install into bore of shaft, on top of H.P. seal. The grease should hold the seat in place; if it falls out, apply more grease.
7. Slide shaft assembly into head. Install Retaining Ring (WT 032) in groove of head. Make sure it is fully inserted in the groove.
8. Refer to the Maintenance Section for viscous fluid filling instructions before using the tool.

